

# MODEL RD4100 SINGLE SPOOL MONO-BLOCK VALVE



## RD4100 SPECIFICATIONS

MAXIMUM OPERATING PRESSURE ..... 3000 PSI  
 MAXIMUM TANK PRESSURE ..... 500 PSI  
 MAXIMUM OPERATING TEMPERATURE ..... 180°F

RECOMMENDED SYSTEM FILTRATION ..... ISO 4406 19/17/14  
 FLOW RATING ..... 15 GPM

## STANDARD FEATURES

- Economical monoblock construction of high tensile strength gray cast iron
- Load check
- Hard chrome plated spool
- Adjustable cartridge relief
- Open center, closed center, and power beyond available
- For use with system flows up to 15 gpm
- For use with system pressures up to 3000 PSI
- Optional top inlet & outlet port locations.

RD41	PORT SIZE	SPOOL TYPE	SPOOL ACTIONS	RELIEF VALVE	INLET LOCATION	OUTLET LOCATION	POWER BEYOND	HANDLE
RD41 Single Spool	2 #10 SAE in & out #8 SAE work	A 3 Way 3 Position Tandem Center	A Spring Center	1 No Relief	A End	1 End W/Power Beyond Option A	A Not Provided	1 Std. Lever Handle
<b>*RD412BA5A1A1-25</b> THE LAST TWO DIGITS ARE RELIEF PRESSURE IN HUNDREDS. EX: 25=2500 psi. ALL RELIEFS ARE SET AT 10 GPM & 105°F ** OFTEN USED WITH NO RELIEF. REVIEW APPLICATION.		B 4 Way 3 Position Tandem Center	B 3 Position Detent	4 Direct Acting Adjustable 500-1500 PSI Set at 1000 PSI	B Top	2 Top W/Power Beyond Options B, C & D	B Conversion Plug Installed	2 Less Handle Only
		C 4 Way 3 Position Open Center Motor Spool	C Friction Detent	5 Direct Acting Adjustable 1500-3000 PSI Set at 2000 PSI			C Power Beyond Plug Installed with #8 SAE	3 Less Complete Handle Assembly
		D 4 Way 4 Position Tandem Center Float Spool	D Float Detent	See SVW Section for Additional Spool Actions	For other relief settings please specify*		D** Closed Center Conversion Plug Installed	5 Tang Spool End Only
								6 Clevis Spool End Only 11 Enclosed Handle

### STANDARD VALVES AVAILABLE:

All standard valves have a load check, a complete lever handle assembly, and an adjustable relief, see table below for settings. For other relief settings, please specify.

VALVE PART NUMBER	SPOOL TYPE			SPOOL ACTION			IN/OUT PORT SIZE	WORK PORT SIZE	RELIEF SETTING	CONVERTIBLE FROM OPEN CENTER TO CLOSED CENTER
	4 WAY 3 POSITION	4 WAY 3 POSITION MOTOR	4 WAY 4 POSITION FLOAT	SPRING CENTER TO NEUTRAL	3 POSITION DETENT	FLOAT DETENT				
RD412BA5A1A1	X			X			#10 SAE	#8 SAE	2000 PSI AT 10 GPM	NO
RD412BA5A2B1	X			X			#10 SAE	#8 SAE	2000 PSI AT 10 GPM	YES
RD412BB5A2B1	X				X		#10 SAE	#8 SAE	2000 PSI AT 10 GPM	YES
RD412CA5A2B1		X		X			#10 SAE	#8 SAE	2000 PSI AT 10 GPM	YES
RD412DD5A2B1			X	X		X	#10 SAE	#8 SAE	2000 PSI AT 10 GPM	YES

VALVES

RD-4100 SINGLE SPOOL PRESSURE DROP

110 SUS OIL AT 115°F			
FLOW (GPM)	Δ P-PSI		
	INLET TO OUTLET	INLET TO A OR B	A OR B TO OUTLET
5	3	10	3
10	11	42	12
15	26	85	32

RD-4100 RELIEF VALVE CURVES

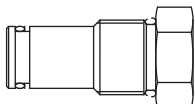
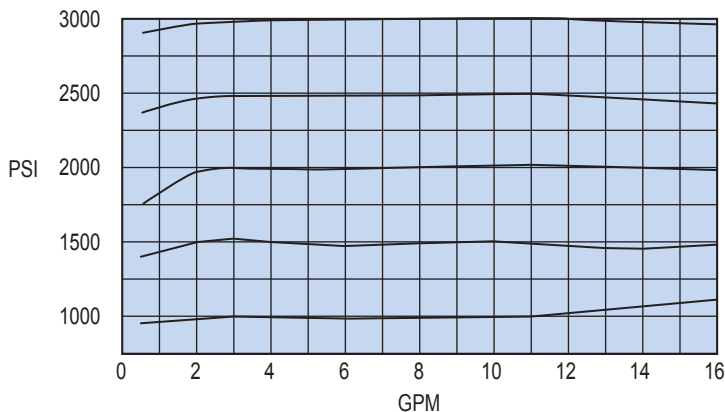

NO RELIEF PLUG



OPEN CENTER CONVERSION PLUG

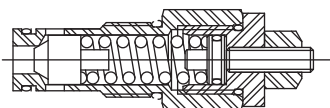

HIGH PRESSURE RELIEF CART.

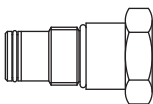

POWER BEYOND CART. (#8 SAE)

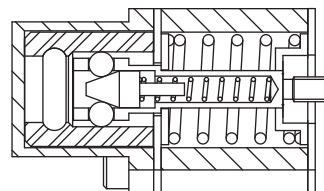

SPRING CENTER FLOAT DETENT

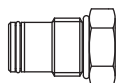

CLOSED CENTER PLUG

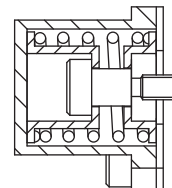

SPRING CENTER

PLEASE NOTE: This closed center option does not provide for the drain off of standby spool leakage. This can allow a very small amount of oil to enter the work ports when in neutral.

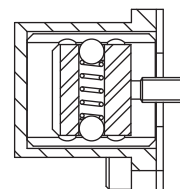

3 POSITION DETENT

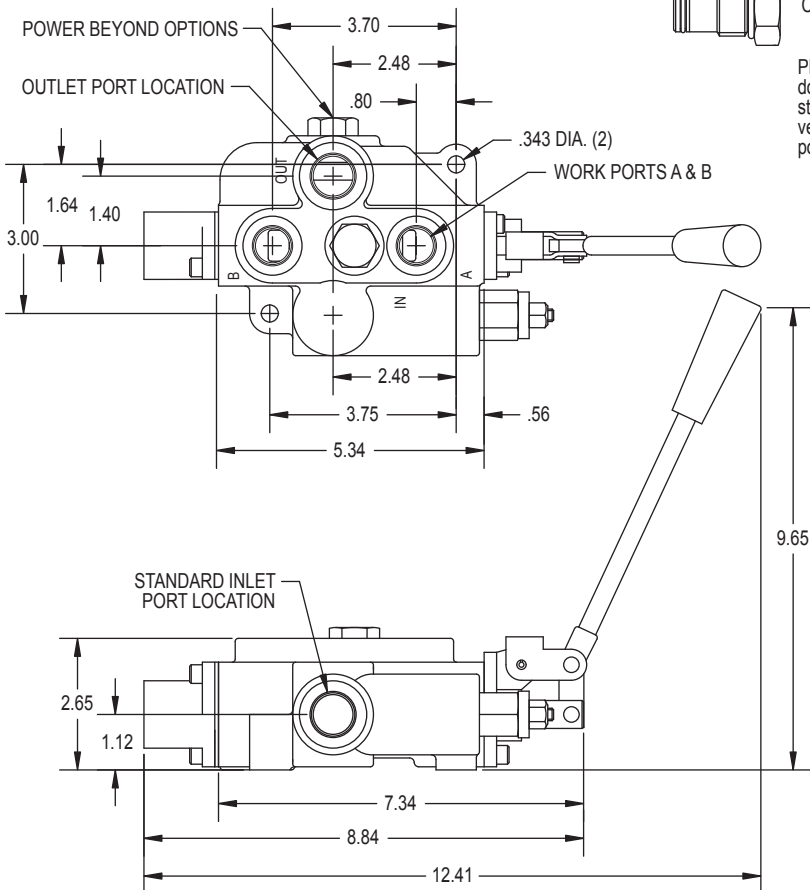

PART NUMBER	DESCRIPTION
660541001	SEAL KIT
660150015	LOAD CHECK KIT
660580003	POWER BEYOND SEAL KIT
660180001	SPRING CENTER KIT
660180002	3 POSITION DETENT KIT
660180003	1 POSITION DETENT KIT
660180051	SPRING CENTER FLOAT KIT
660180005	COMPLETE HANDLE KIT
660180011	HANDLE KIT
660180032	CLEVIS SUB-ASSY
660180031	PIN KIT
660280004	RELIEF PLUG
660280009	RELIEF CART. 1500-3000 PSI
660280011	RELIEF CART. 500-1500 PSI
200400030	OPEN CENTER PLUG
660280001	POWER BEYOND CART. (#8 SAE)
660280002	CLOSED CENTER PLUG

VALVES